

POWERTEC®

STRENGTH

P-LM13

Manual

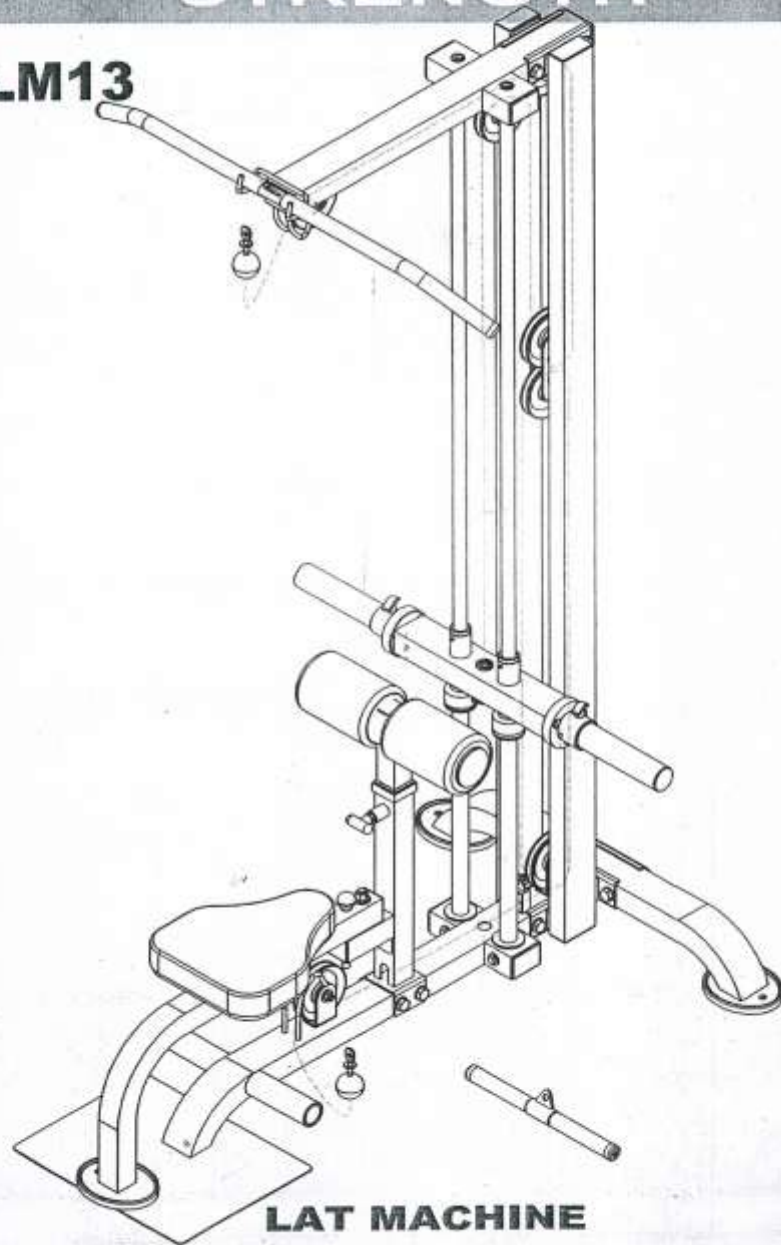

LAT MACHINE

Thank you for purchasing your new Powertec Fitness Equipment.
To maximize the use of this equipment, please take a moment to study and understand
Assembly instructions, be careful to follow the sequence as provided in this Manual.

Important Note:

Do Not fully tighten bolts until assembly has been completed!
Some components are pre-assembled at the factory; please make sure to tighten all bolts
Upon completion of all assembly, including parts delivered pre-assembled.



Maintenance!



The safety and performance of this product can be maintained only if it is examined
regularly for damage and normal wear.
Examine the equipment before each use for damage and wear. Replace damaged and
worn components immediately or put the equipment out of use until repaired.

Inspect Daily / Before Each Use:

Inspect system. Make sure it is in good condition and operates smoothly.
If you find damage, **DO NOT USE**. Contact your authorized Powertec dealer or
Powertec Customer Service for assistance.

Inspect Daily/After Each Use:

Clean system with a clean, dry cloth. Use a mild detergent or spray cleaner on upholstery.
Do not use cleansers containing enzymes.

Inspect Weekly:

Clean system fully with a clean cloth and ammonia-based cleaner. Touch up any
scratches with touch-up paint to prevent rust, if necessary.

Inspect Monthly:

Examine the frame for signs of cracking or permanent bending. Do not use the equipment
if you see this. Contact Powertec Customer Service immediately.
If you have any questions on the correct use or maintenance of this equipment, call your
authorized distributor or Powertec Customer Service at 1-800-250-6665

Our Customer Service Mission:

"Committed to Stronger Lives"
by providing friendly and understanding service

HARDWARE LIST



Part NO.30 Hex Bolt 3/8"x1/2"

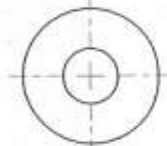

Part NO.38 Washer 3/8"

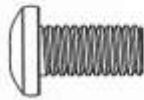

Part NO.31 Hex Bolt 3/8"x3/4"

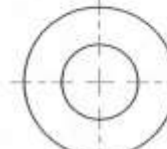

Part NO.39 Washer 1/2"

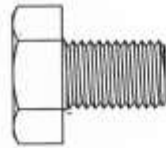

Part NO.36 Hex Bolt 1/2"x3/4"

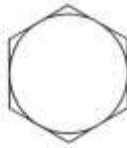

Part NO.40 Nylon Nut 3/8"

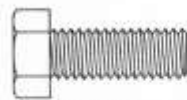

Part NO.32 Hex Bolt 3/8"x1"



Part NO.41 Nylon Nut 3/8"

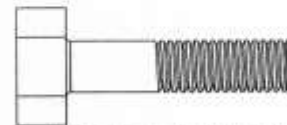

Part NO.34 Hex Bolt 3/8"x1 5/8"



Part NO.42 Nylon Nut 1/2"

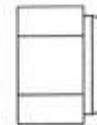

Part NO.33 Hex Bolt 3/8"x2 1/2"

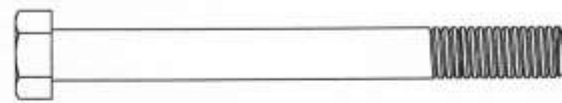

Part NO.35 Hex Bolt 3/8"x3 3/4"

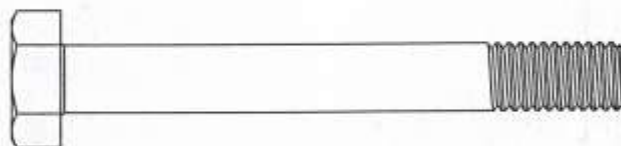

Part NO.37 Hex Bolt 1/2"x4 1/8"

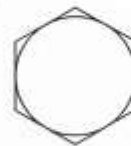

POWERTEC[®]

P-LM13

LAT MACHINE

PART LIST

Part#	Description	QTY
1	Rear Base Tube	1
2	Front Base Tube	1
3	Adjustment Tube	1
4	Upright (R&L)	1
5	Top Upright	2
6	Seat Tube	1
7	Support Tube	1
8	Weight Horn	2
9	Sliding Tube	1
10	Top Lat Bar	2
11	Low Lat Bar	1
12	Adjustment Tube	1
13	Support Tube	1
14	Linkage Plate	1
15	Fixed Tube	2
16	Weight Support Tube	1
17	Linkage Plate	2
18	Footplate	1
19	Cable	1
20	Cable	1
21	Foam Roller	1
23	Chrom End Cap	2
24	Bumper	2
25	Seat Pad	2
26	Pulley	1
27	Ball Head Lock Pin	2
28	Plastic Bumper	1
29	Collar	2
30	Hex Bolt 3/8"x1/2"	2
31	Hex Bolt 3/8"x3/4"	6
32	Hex Bolt 3/8"x1"	6
33	Hex Bolt 3/8"x 2 1/2"	1
34	Hex Bolt 3/8"x1 5/8"	1
35	Hex Bolt 3/8"x3 3/4"	2
36	Hex Bolt 1/2"x3/4"	2
37	Hex Bolt 1/2"x4 1/8"	4
38	Washer 3/8"	6
39	Washer 1/2"	6
40	Nylon Nut 3/8"	17
41	Nylon Nut 3/8"	2
42	Nylon Nut 1/2"	3
		7

 **POWERTEC**®

P-LM13

LAT MACHINE

EXPLODED DIAGRAM

POWERTEC®

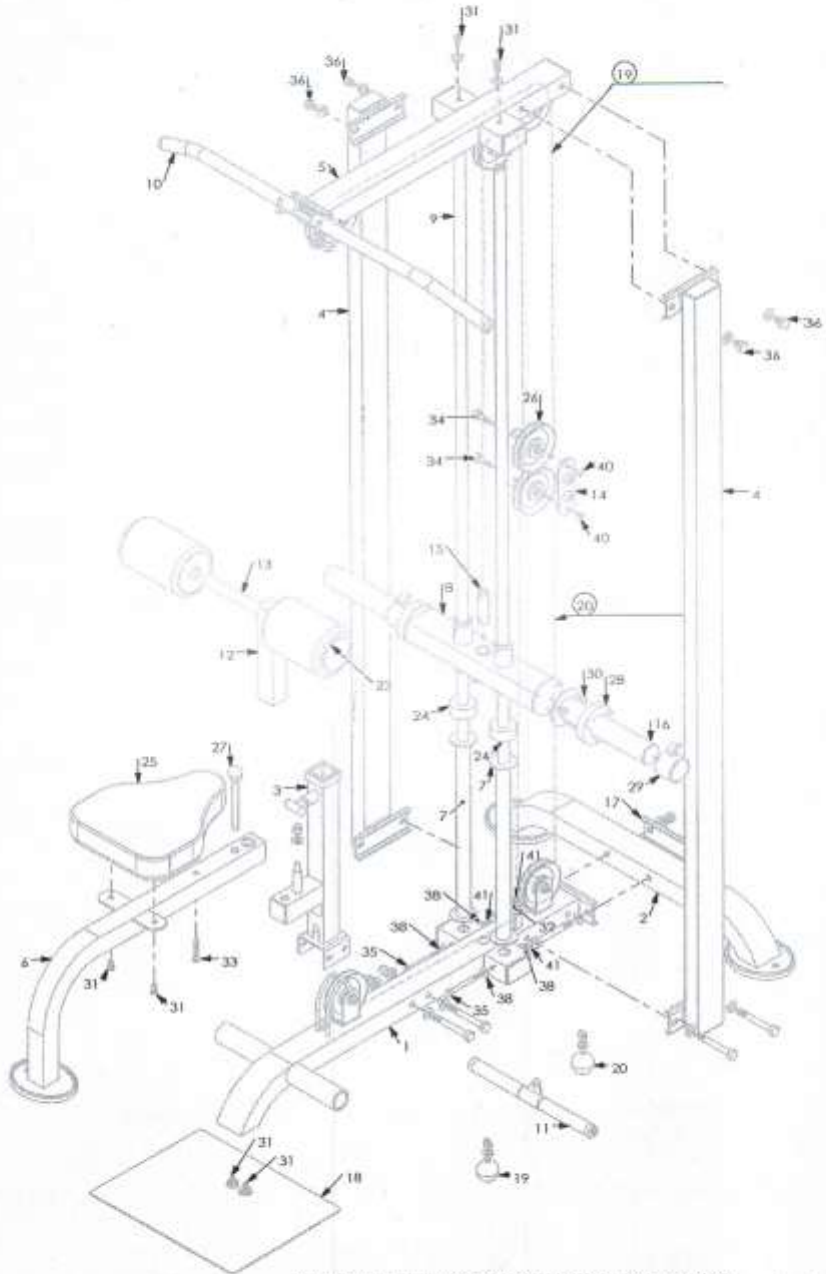

Remarks: All unmarked Washers are (39), Bolts are (37),
and all unmarked Nylon Nuts are (42).

P-LM13
LAT MACHINE

ASSEMBLY ONE

 **POWERTEC**®

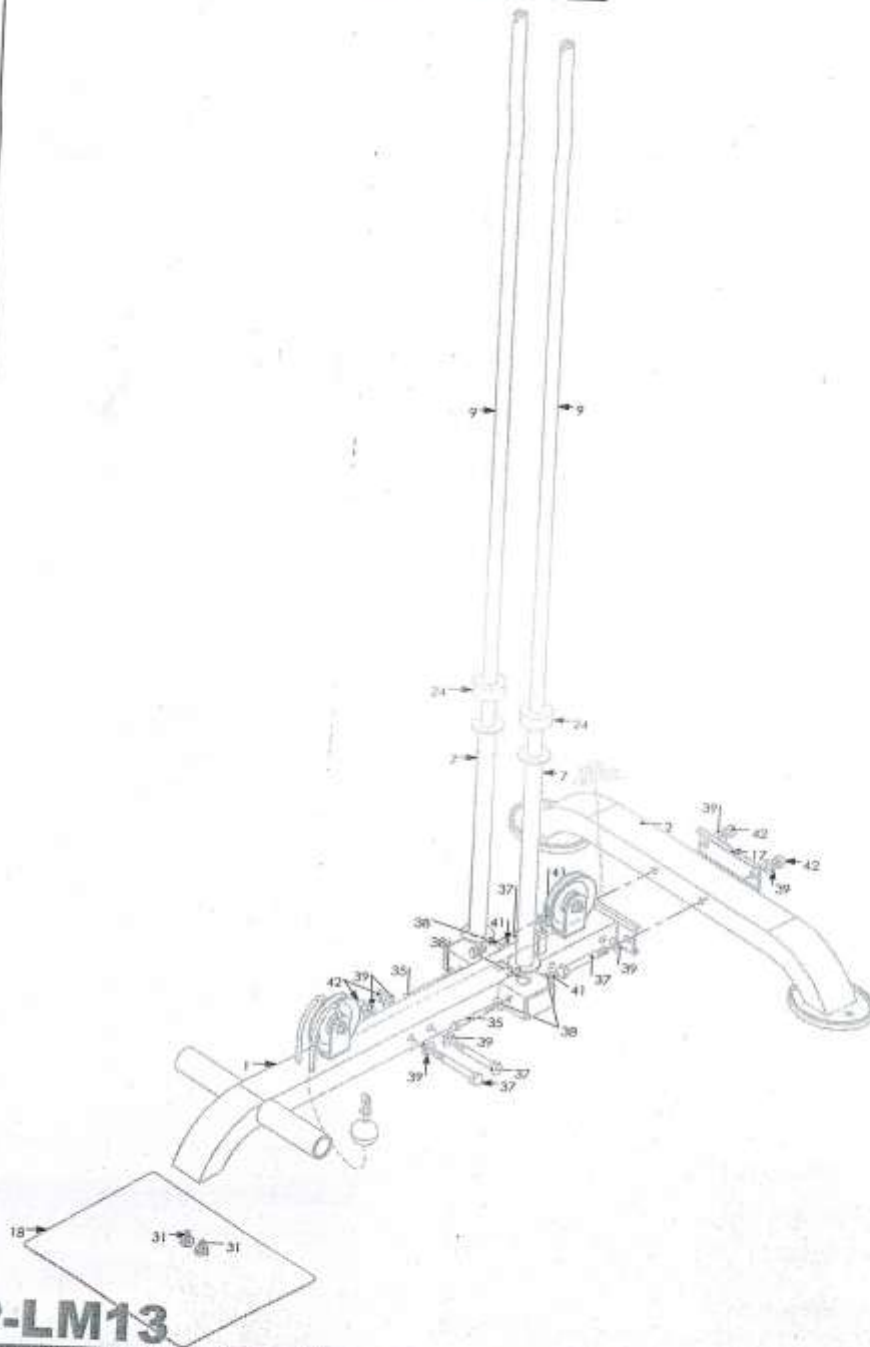

P-LM13

LAT MACHINE

ASSEMBLY TWO

POWERTEC[®]

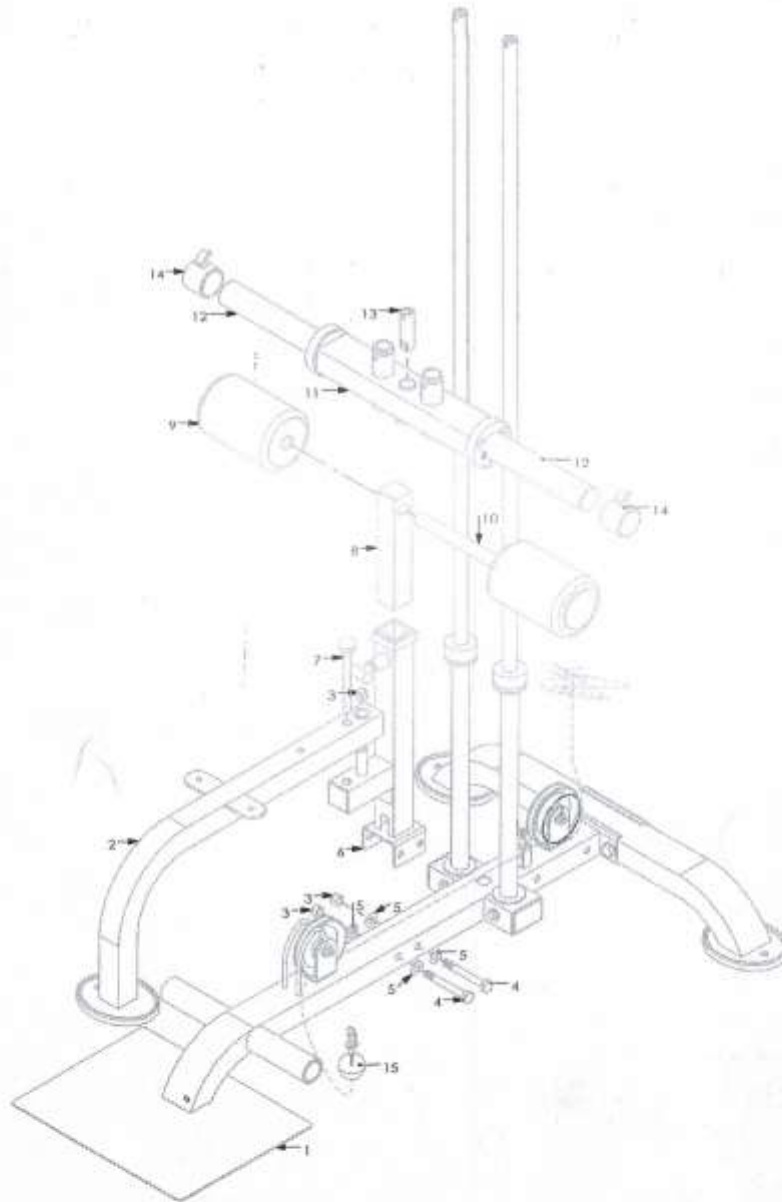

P-LM13

LAT MACHINE

ASSEMBLY THREE

POWERTEC[®]

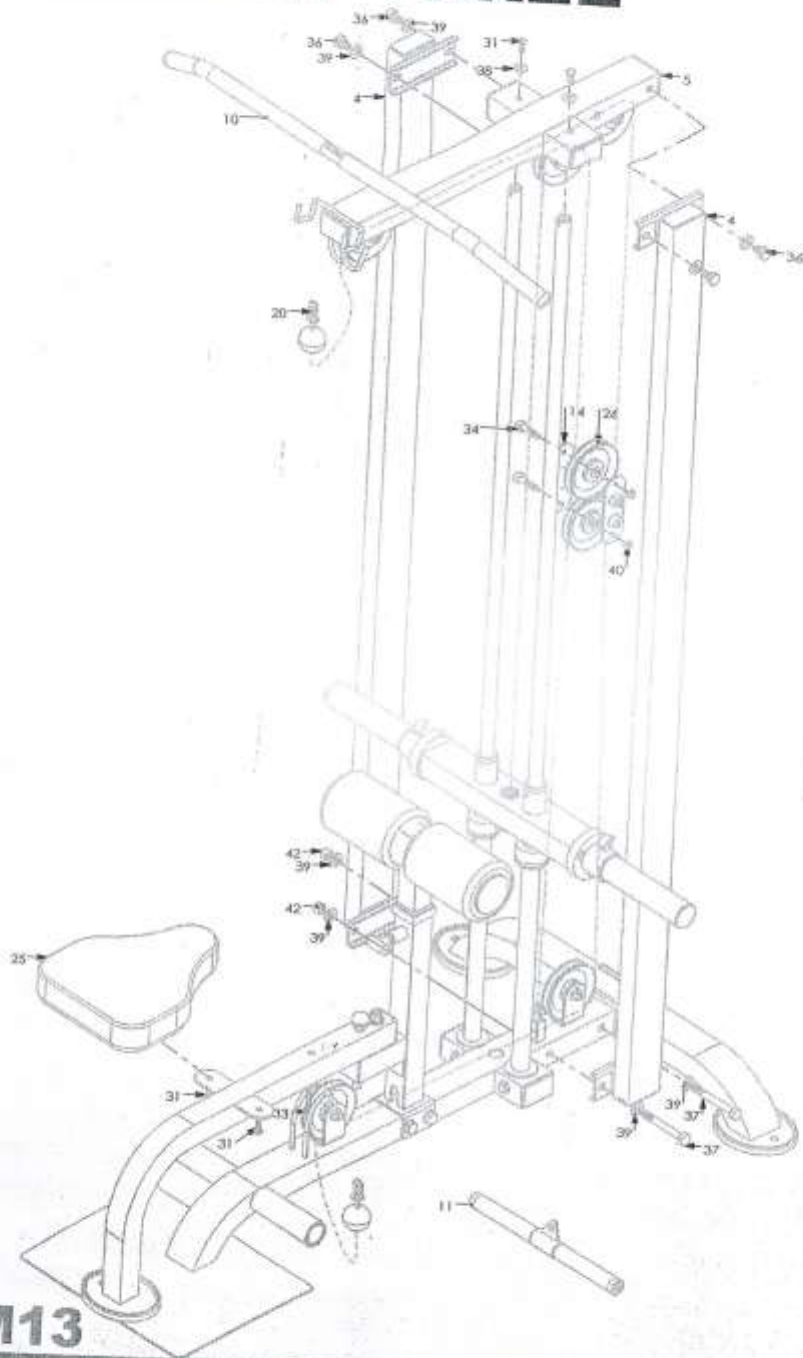

P-LM13
LAT MACHINE

POWERTEC IS NOT LIABLE IF THE TRAINER SHOULD INJURE THEMSELVES WHILE USING POWERTEC EQUIPMENT OR WHILE PERFORMING THE TRAINING ROUTINE

 **POWERTEC®**

STRENGTH

POWERTEC INC.

2100 East Artesia Blvd
Long Beach, CA 90805

Phone: (800)250-6665

Fax: (714)908-0493

service@powertecfitness.com

www.powertecfitness.com

Box 2 = 110 x 58 x 27

Box 1 = 2050 x 19 x 17

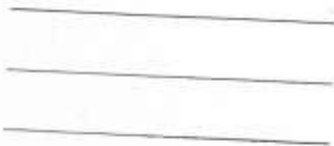

Place
Stamp
Here

Powertec inc.

2100 East Artesia Blvd
Long Beach, CA 90805

Phone: (800)250-6665

Fax: (714)908-0493

www.powertecfitness.com





P-LM13 Powertec Lat Machine



The Lat Machine comes in two cartons. Box 1 is 205cm x 19cm x 17cm and weighs 26kgs. Box 2 is 110cm x 58cm x 27cm and weighs 47kgs.



Put the footplate on the base section first. I used the box to rest the base on while I screwed in the bolts. I tightened these with the allen key provided.



Now I thought it would be a good idea to unwind the base cable from the base section. I then used some of the protective bubble wrap from some of the parts and placed the cable inside. I didn't want to leave it lying on the ground where I may accidentally step on it.



The rear support needs attaching to the base section. Don't forget the backing plate!



Now time for the chrome guide tubes. The threaded section is up the top. The end with holes is at the bottom. Once you put the tubes in place, put the 3/8" bolts through and secure with the nuts. Just do them finger tight.



You then slide the long support tubes down the guide rails. Don't forget to rubber bumpers on too. They should be at the top. They will protect the bottom nylon bushes on the weight carriage.



Before we can install the uprights for the knee pads, we need to take the pulley at the rear of the base off so we can feed the cable back through. **DON'T JUST PLONK THE UPRIGHT ON TOP OF THE CABLE!**

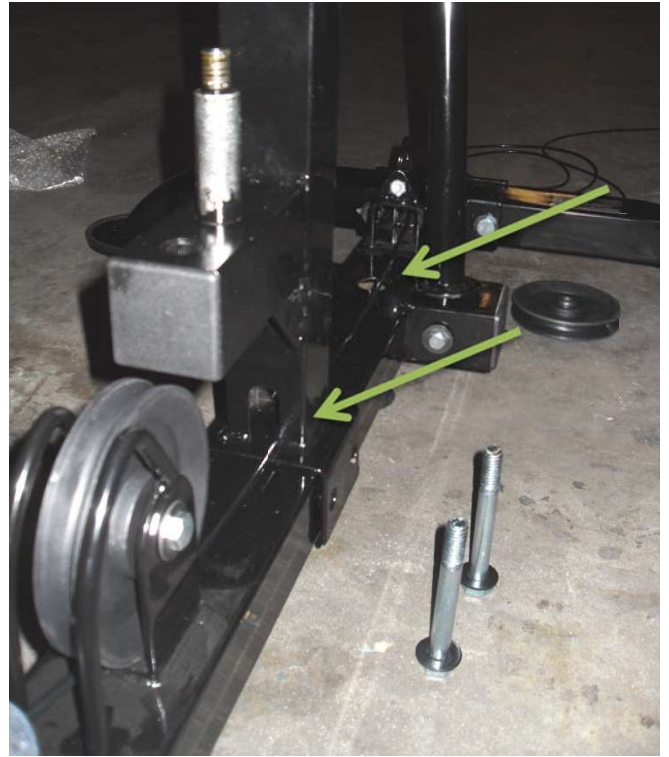

You can see in the picture above how the cable travels through the channel in the knee pad upright and the lower cable anchor position.



After I ran the cable through I put the pulley back in place, then I placed it back in the bubble wrap.

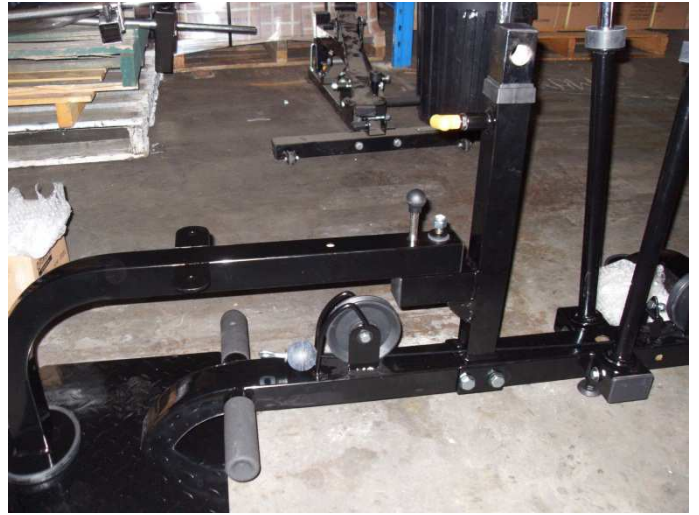

Then get out the seat support piece and position it on the spindle.



Put the weight carriage on. Have the threaded section up, this is where the top cable will screw in.



The side supports are the next to go on. Unless you have got three arms it is probably a good idea to get someone to help you here. Hold the supports in place and pop the bolts in place. Once you have the nuts finger tight the uprights will stay in place.



Just rest the top section on top of the chrome guide rails and use the 4 short bolts and washers to secure it in place.

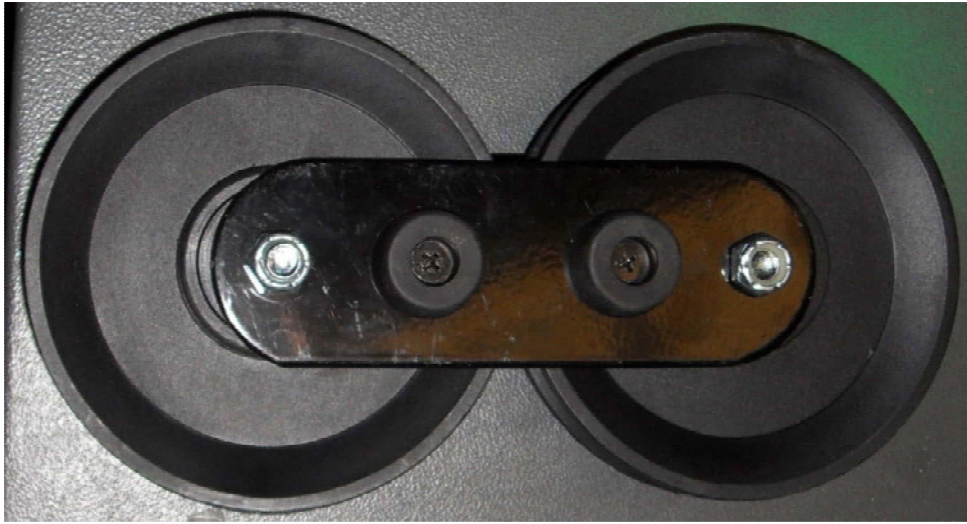

Now for the fun part – the cable! Don't stress cause the cable is pretty much in place from the factory. First up you need to remove one pulley the linkage section (the two pulleys together above).



On the top section, pull some slack on the cable from the rear pulley. This is where you place the linkage section. You can see in the picture above that it will hold in place. There is a picture from behind to hopefully make it clearer.



The bottom cable just loops up around the linkage section and anchors at the bottom. I have drawn the cable path above to simplify it.

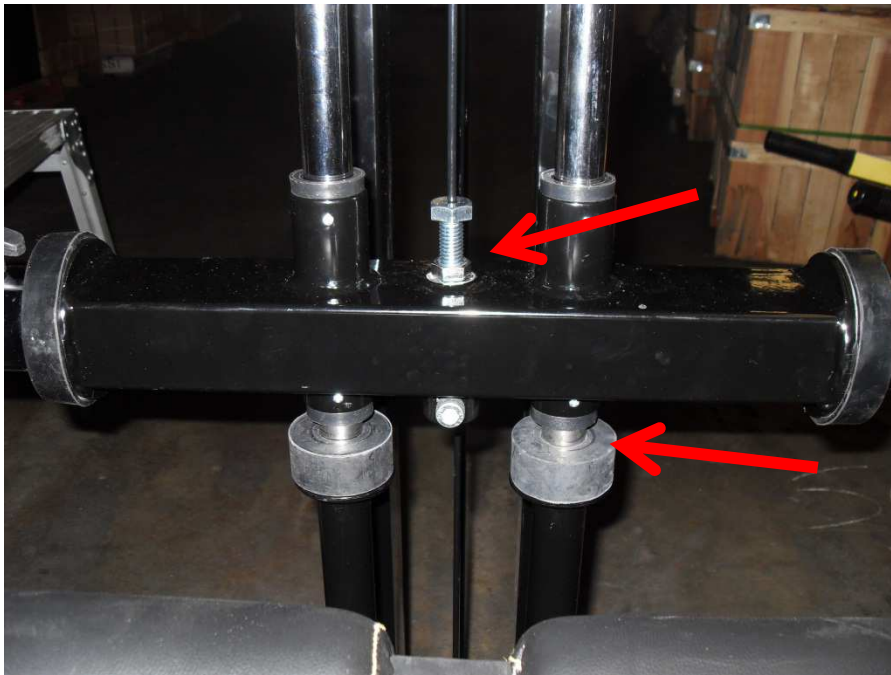

Screw the bolt into the weight carriage and tighten the lock nut in place once you have got the carriage in the right position. What is the right height? I have the carriage sitting a little off the bumpers with no weight on. Once you put weight on, the carriage will settle on the bumpers. Over time you will need to tighten the bolt down as the cable stretches slightly.



Put the knee support and base seat on and you have got yourself a lat machine!

